



# SCM800

## Eight-Channel Microphone Mixer

The Shure eight-channel microphone mixer, SCM800, user guide.  
Version: 6 (2020-D)

# Table of Contents

<b>SCM800 Eight-Channel Microphone Mixer</b>	<b>3</b>	<b>EQUALIZER FUNCTIONS</b>	<b>11</b>
<b>IMPORTANT SAFETY INSTRUCTIONS</b>	<b>3</b>	<b>Internal Modifications</b>	<b>12</b>
<b>Description</b>	<b>4</b>	ABOUT PRINTED CIRCUIT BOARD MODIFICATIONS	12
Features	4	Inserting A 15 dB Microphone Preamp Pad	12
<b>SCM800 Front Panel</b>	<b>4</b>	Line-Level Output to Mic-Level Output	13
SCM800 REAR PANEL	6	Disable Master Level Control	13
<b>SYSTEM SETUP</b>	<b>7</b>	Change Limiter Threshold	13
SCM800/E CONNECTIONS	7	Local Aux Operation	13
OUTPUT LIMITER THRESHOLD SETTINGS	8	Send/Return (Insert) to Direct Out	13
LINKING MULTIPLE SCM800 MIXERS	9	Send/Return to Direct Out Post-Fader	13
LINKING TO OTHER SHURE AUTOMATIC MIXERS	9	Remote Volume Control of Channels	14
USING AN SCM800 AS A SUBMIXER	10	<b>Specifications</b>	<b>14</b>
ADDITIONAL LINK CABLES	10	<b>Replacement Parts</b>	<b>16</b>
<b>BASIC MIXER OPERATION</b>	<b>10</b>	<b>Service Statement</b>	<b>16</b>
<b>LIMITER</b>	<b>10</b>	<b>Certifications</b>	<b>16</b>

---

# SCM800

## Eight-Channel Microphone Mixer



---

### IMPORTANT SAFETY INSTRUCTIONS

1. READ these instructions.
2. KEEP these instructions.
3. HEED all warnings.
4. FOLLOW all instructions.
5. DO NOT use this apparatus near water.
6. CLEAN ONLY with dry cloth.
7. DO NOT block any ventilation openings. Allow sufficient distances for adequate ventilation and install in accordance with the manufacturer's instructions.
8. DO NOT install near any heat sources such as open flames, radiators, heat registers, stoves, or other apparatus (including amplifiers) that produce heat. Do not place any open flame sources on the product.
9. DO NOT defeat the safety purpose of the polarized or grounding type plug. A polarized plug has two blades with one wider than the other. A grounding type plug has two blades and a third grounding prong. The wider blade or the third prong are provided for your safety. If the provided plug does not fit into your outlet, consult an electrician for replacement of the obsolete outlet.
10. PROTECT the power cord from being walked on or pinched, particularly at plugs, convenience receptacles, and the point where they exit from the apparatus.
11. ONLY USE attachments/accessories specified by the manufacturer.
12. USE only with a cart, stand, tripod, bracket, or table specified by the manufacturer, or sold with the apparatus. When a cart is used, use caution when moving the cart/apparatus combination to avoid injury from tip-over.



13. UNPLUG this apparatus during lightning storms or when unused for long periods of time.
14. REFER all servicing to qualified service personnel. Servicing is required when the apparatus has been damaged in any way, such as power supply cord or plug is damaged, liquid has been spilled or objects have fallen into the apparatus, the apparatus has been exposed to rain or moisture, does not operate normally, or has been dropped.
15. DO NOT expose the apparatus to dripping and splashing. DO NOT put objects filled with liquids, such as vases, on the apparatus.
16. The MAINS plug or an appliance coupler shall remain readily operable.
17. The airborne noise of the Apparatus does not exceed 70dB (A).
18. Apparatus with CLASS I construction shall be connected to a MAINS socket outlet with a protective earthing connection.
19. To reduce the risk of fire or electric shock, do not expose this apparatus to rain or moisture.
20. Do not attempt to modify this product. Doing so could result in personal injury and/or product failure.
21. Operate this product within its specified operating temperature range.

	This symbol indicates that dangerous voltage constituting a risk of electric shock is present within this unit.
	This symbol indicates that there are important operating and maintenance instructions in the literature accompanying this unit.

## Description

The Shure Model SCM800 is a full-featured, eight-channel microphone mixer for sound reinforcement, general audio recording, and audio-visual systems. Any low-impedance, balanced dynamic or condenser microphone, including a wireless microphone system, can be used with the SCM800 mixer.

Each SCM800 accepts up to eight microphone- or line-level inputs and one aux-level input (two input jacks feed the same channel). Up to four SCM800 mixers can be linked to provide up to 32 input channels. Each input channel has a two-band equalizer, switchable microphone- or line-level operation, switchable 48 V phantom power, and a ¼-inch send/ receive insert jack.

The SCM800 operates on 120 Vac power; the SCM800E operates on 230 Vac power. Both models are supplied with rack-mounting hardware, link cable and removable block terminal connectors. An accessory rack panel adapter (Model RKC800, available separately) converts the removable block input and output connectors to XLR connectors, and the Aux connectors to phono jacks.

## Features

- Compatible with Shure SCM810 and FP410 automatic microphone mixers
- Adjustable EQ per channel: low-frequency rolloff and highfrequency shelving
- 48 V phantom power selectable for each input
- Active balanced microphone- and line-level inputs and line-level output
- Highly RF-resistant chassis and circuitry
- LED indication of channel clipping
- Linking capability for systems up to 32 microphones
- Two Aux-level input jacks that feed one channel
- Insert jack on each channel
- Manual mixing of input channels
- Front-panel headphones output with level control
- Peak-responding output limiter with selectable thresholds and LED indicator

# SCM800 Front Panel

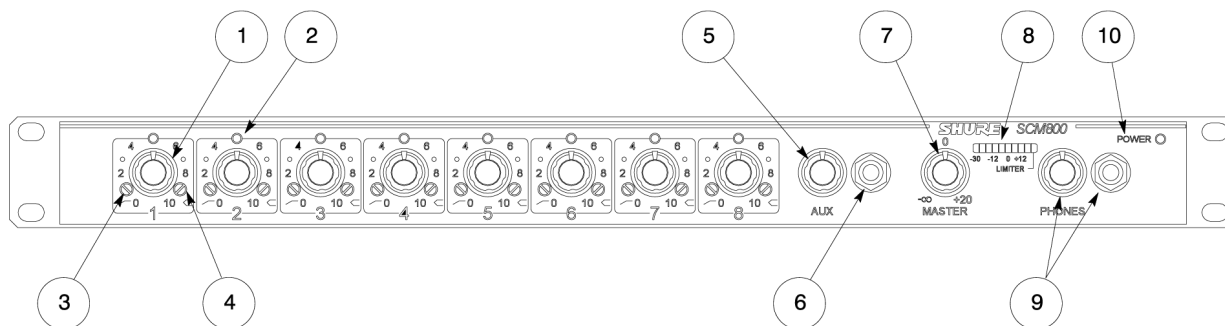

MODEL SCM800/E FRONT PANEL FIGURE 1

## 1. Microphone Channel Gain Controls 1 - 8:

Allows adjustment of microphone gain.

## 2. Input LED 1 - 8:

Lights red at 6 dB below clipping level.

## 3. Low-Cut Filter 1 - 8:

Recessed screwdriver adjustment provides adjustable low-frequency rolloff (high pass) to reduce undesirable low-frequency signals.

## 4. High-Frequency Shelving Filter 1 - 8:

Recessed screwdriver adjustment provides level boost or cut in mid/high frequency region for compensation of off-axis lavalier microphones, or for cutting the high-frequency sibilance of vocal microphones.

## 5. AUX Level Control:

Sets the input level for aux-level equipment connected to the adjacent 1/4-inch phone jack **INPUT** or rearpanel 1/4-inch **AUX** input.

## 6. AUX INPUT 1/4-inch Phone Jack:

Mixes external auxiliary- or line-level sources, i.e., tape recorders, into output. Signal appears at output of all linked mixers.

## 7. MASTER Level Control:

Determines the overall mix level.

## 8. Output Level Meter:

Nine-segment LED meter indicates peak output signal level. Last LED indicates limiter action.

## 9. PHONES Control and 1/4-inch Phone Jack:

Permits monitoring of mixer output through headphones. **PHONES** control determines headphones output level.

## 10. POWER LED:

Lights green when unit is powered.

## SCM800 REAR PANEL

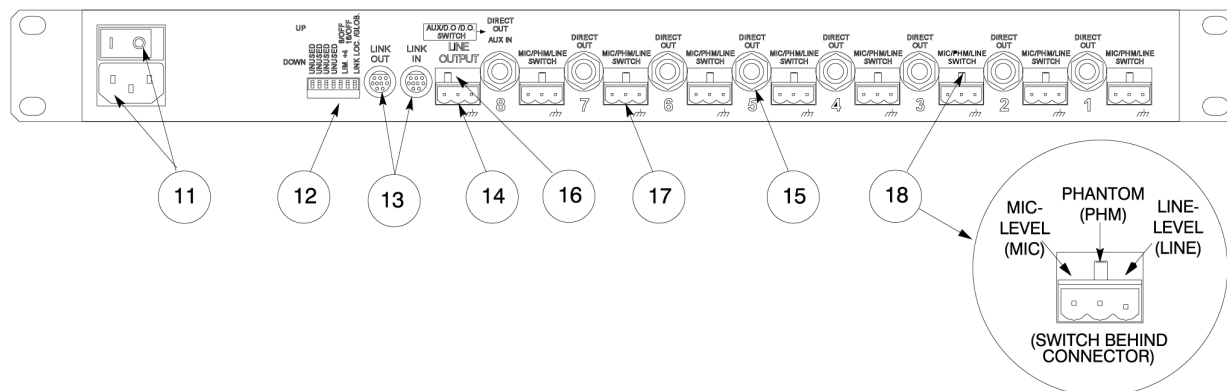

MODEL SCM800/E REAR PANEL FIGURE 2

### 11. SCM800: 120 VAC Power Connector and Rocker Switch:

Switch turns unit on when power cord is plugged into 120 Vac.

### SCM800E: 230 VAC Power Connector and Rocker Switch:

Switch turns unit on when power cord is plugged into 230 Vac.

### 12. DIP Switch:

The 7-position DIP switch provides control of the output limiter threshold (see DIP Switches).

### 13. LINK IN/OUT Jacks:

Permit multiple SCM800 mixers to be stacked for additional inputs.

### 14. LINE OUTPUT Removable Block Connector:

Active balanced line-level signal for connection to amplifiers, recorders or other mixers. If necessary, output level can be changed to microphone level. Refer to the Internal Modifications section of this manual.

### 15. SEND/RECEIVE 1/4-inch Insert Jacks:

Post-fader, post-EQ insert point to add external compressor/limiter, graphic or parametric EQ, or other signal processors. Tip is send, ring is return. Can be modified for use as a Direct Out (see Internal Modifications).

### 16. AUX/INS/INS 3-Position Slide Switch:

Selects either aux input function or insert function for channel 8 (only) Insert jack. Left switch position is AUX IN; center and right positions are INSERT. This switch is located behind Line Output connector.

### 17. INPUT 1-8 Removable Block Connectors:

Active balanced microphone- or line-level inputs.

### 18. Input 1 - 8 MIC/PHM/LINE 3-Position Slide Switch:

Selects operation at either microphone-level (left), microphone-level with 48 V phantom power (center), or line-level (right) signals. This switch is located behind the removable block connector.

## SYSTEM SETUP

### Rack mounting the SCM800/E

To mount an SCM800 or SCM800E in a standard 483 mm (19-inch) audio equipment rack so that the front panel faces out, as shown in Figure 4. Then secure the mixer to the rack with the four supplied Phillips head screws.

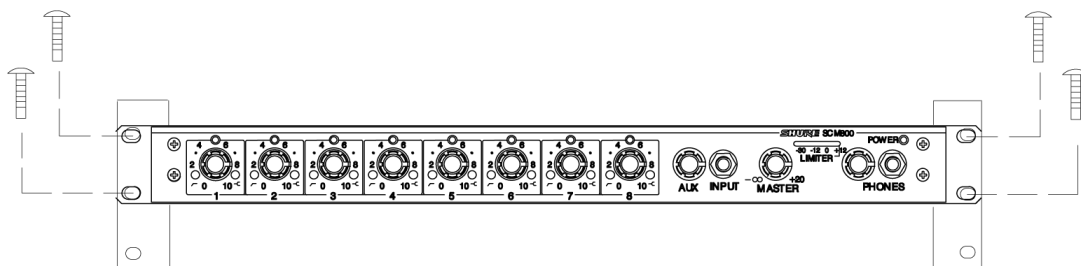

RACK MOUNTING THE SCM800/E FIGURE 4

## SCM800/E CONNECTIONS

Refer to Figure 5 and proceed as follows:

1. Connect microphone- or line-level signal sources to the Channel Input connectors (use conventional two-conductor shielded cables).
2. Insert a screwdriver or similar tool into the slot above each block connector and adjust the input slide switch as required: microphone level (left position), 48 V phantom power (center position), or line level (right switch position).
3. Connect the Line Level Output of the SCM800/E to the input of other mixers, equalizers, amplifiers, or recorders. If multiple SCM800/E mixers are to be used, refer to the *Mixer Linking* paragraph of this manual.
4. If headphone monitors are to be used, plug them into the ¼-inch PHONES jack on the front panel.
5. Connect the power cord to a 120 Vac (SCM800) or 230 Vac (SCM800E) power source.

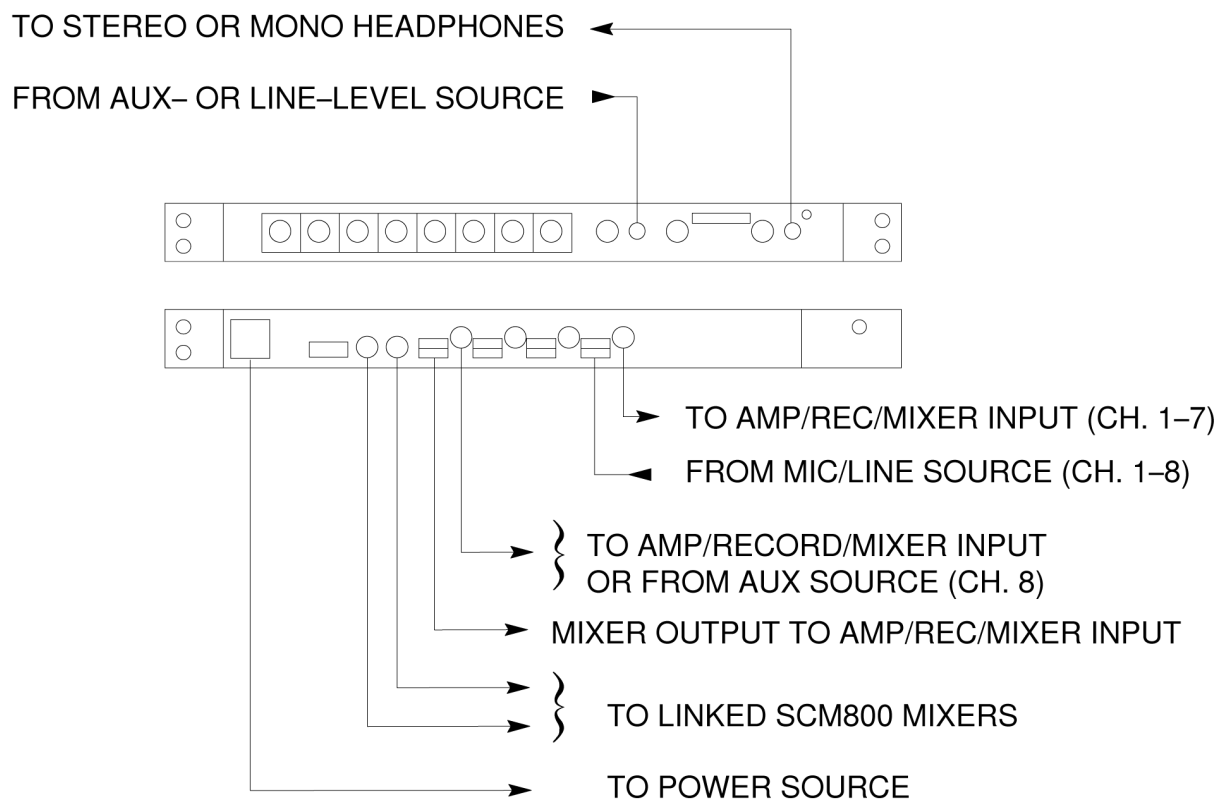

SCM800/E AUDIO CONNECTIONS FIGURE 5

## OUTPUT LIMITER THRESHOLD SETTINGS

The DIP switches on the rear-panel, shown below in Figure 3, control the output limiter threshold settings. Switches 5 and 6 change the output limiter threshold to OFF (default setting), +16 dBm, +8 dBm, or +4 dBm. Other settings are as shown in the table at right. Refer to the *Internal Modifications* section of this manual for additional settings.

**NOTE:** Switches 1, 2, 3, 4 and 7 are inactive and are not used.

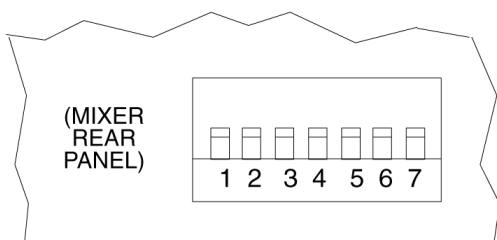

OUTPUT LIMITER THRESHOLD DIP SWITCH FIGURE 3



## DIP SWITCH FUNCTIONS

DIP Switch Position	Limiters Threshold
5 Up, 6 Up	Limiters Off (default)
5 Down, 6 Up	+8 dBm
5 Up, 6 Down	+16 dBm
5 Down, 6 Down	+4 dBm

## LINKING MULTIPLE SCM800 MIXERS

Up to four SCM800 mixers can be “linked” using the supplied link cables. If additional inputs are needed, such a configuration can provide 32 mic inputs. Refer to Figure 6. When multiple SCM800 mixers are linked, all input signals appear at all linked mixer outputs—there is no master-slave relationship. The output controls and functions of each linked mixer are post-link and do not affect the signals appearing at other linked mixer outputs. Each mixer’s Master level control only controls its own output. Each output can be used independently. In a linked system, the Aux input of any mixer appears at each linked mixer’s output. See Internal Modifications to defeat the linking of Aux signals.

Link jacks should be connected sequentially: the LINK OUT of one mixer to the LINK IN of the next, leaving one LINK OUT and one LINK IN unconnected.

**NOTE:** Each doubling of the number of linked mixers decreases the master output level by 6 dB.

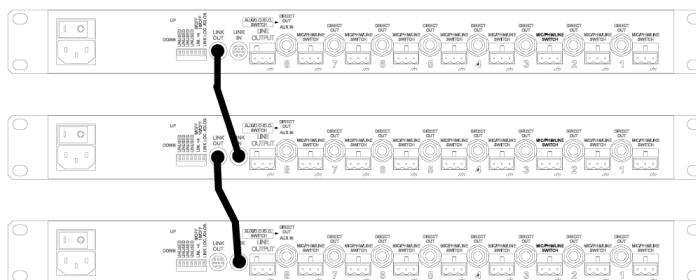

LINKING MULTIPLE SCM800/E MIXERS FIGURE 6

## LINKING TO OTHER SHURE AUTOMATIC MIXERS

An SCM800 can be interfaced with Shure SCM810 and FP410 automatic microphone mixers via the link jacks. Linking an SCM800 is equivalent to adding an additional mixer with eight open microphones to a system. Because of the loading effects of additional open microphones, only one SCM800 can be linked to an automatic system. When using more than one SCM800 with other Shure automatic mixers, connect them as described in the following section.

**NOTE:** When linking an SCM800 to an automatic system, use the SCM800 LINK OUT jack to interface with the LINK IN jack of the automatic system (see Figure 7).

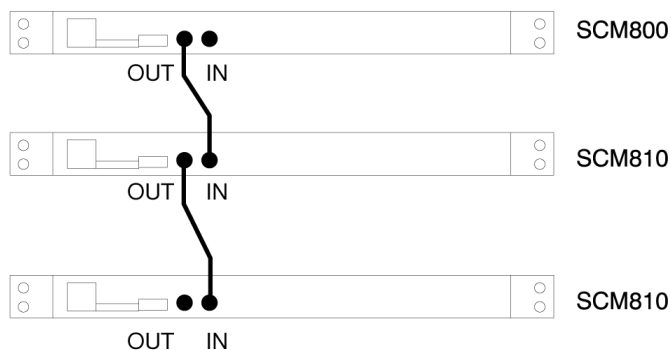

LINKING AN SCM800/E TO OTHER AUTOMATIC MIXERS FIGURE 7

## USING AN SCM800 AS A SUBMIXER

The master output of the SCM800 (or the output of a mixer in a group of linked SCM800 mixers) can be connected to a channel input or the aux input of an automatic mixer, or other types of mixers. See Figure 8.

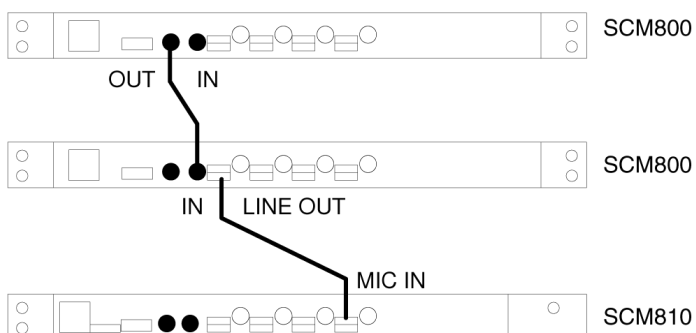

USING AN SCM800/E AS A SUBMIXER FIGURE 8

## ADDITIONAL LINK CABLES

Additional 381 mm (15 in.) link cables are available as Shure Part No. 95A8889. Longer cables in a variety of lengths are available from Apple Computer as computer printer connections; they are variously referred to by Apple as “shielded serial cable with two mini DIN-8 connectors,” and “Apple System Peripheral-8 Cable.”

## BASIC MIXER OPERATION

1. Turn on the Power switch.
2. Adjust each channel level so that its Overload LED flickers only during very loud speech or noise.
3. Turn unused channel controls full counterclockwise.
4. Adjust the Low-Cut and High-Frequency controls adjacent to each Input Gain control until all microphones sound alike.
5. Adjust the SCM800 Master level control for the desired output level, as indicated by the output peak meter.
6. Adjust the headphones volume level with the PHONES control knob.

# LIMITER

The SCM800's output limiter prevents distortion during loud program peaks without affecting normal program levels. Increasing the individual or Master level controls will increase the average output and, in turn, the amount of limiting. The limiter prevents excessive overloading of devices connected to the SCM800 output. As supplied, the limiter is defeated.

The limiter threshold can be set for a peak output level of +4, +8, or +16 dBm. With the threshold set at +16 dBm, the mixer has 12 dB of headroom at a nominal level of +4 dBm. Refer to the Internal Modifications section for information on how to change the limiter's settings.

## EQUALIZER FUNCTIONS

### Low Cut Filter (High-Pass)

The low-cut (or high-pass) filter allows all frequencies above its cutoff point to pass from filter input to filter output without attenuation, while frequencies below the cutoff are attenuated (see Figure 9). The cutoff point is defined as the frequency where the signal has dropped 3 dB relative to the flat, or bandpass, region. Below the cutoff point, the filter exhibits increasingly more attenuation as the frequency diminishes. The rate at which this attenuation occurs is defined in decibels per octave (dB/oct). The SCM800 has a one-pole, low-cut (highpass) filter of 6 dB per octave. Low-cut filters are ideally used for attenuating, or rolling off, the audio signal where extraneous noise, excessive proximity effect, or other unwanted material is present. For example, the low-frequency vibration cause by footsteps and vehicle traffic can be transmitted through microphone stands to the microphone, and then into the sound system. These frequencies, typically ranging from 5 to 80 Hz, are generally not desirable.

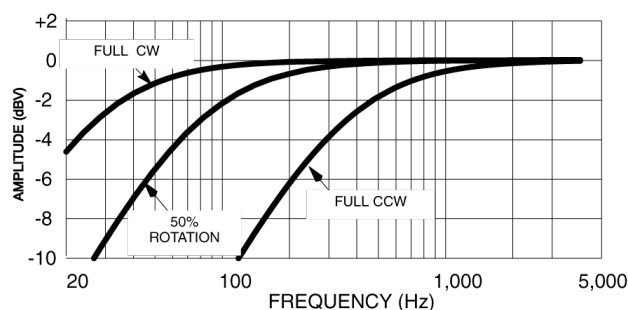

LOW-CUT FILTER EFFECTS

LOW-CUT FILTER EFFECTS FIGURE 9

### High-Frequency Shelving

The fixed-frequency equalizer produces a 6 dB boost or cut at 5 kHz and above (see Figure 10). High-frequency shelving is extremely useful for boosting flat frequency response, tempering very sibilant vocal microphones, or enhancing the sound of off-axis lavalier microphones.

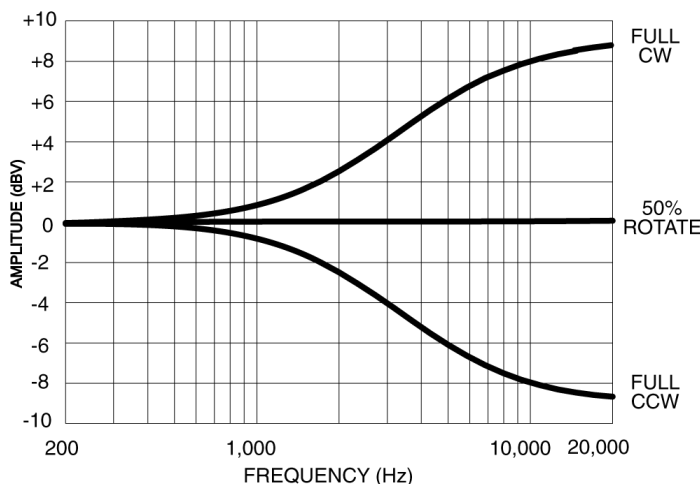

HIGH-FREQUENCY SHELVING EFFECTS

HIGH-FREQUENCY SHELVING EFFECTS FIGURE 10

## Internal Modifications

**NOTE:** Remove AC power before opening the unit.

### ABOUT PRINTED CIRCUIT BOARD MODIFICATIONS

- A jumper is represented by “X” on the printed circuit board legend, a resistor is represented by an “R.”
- The first number in the reference designator indicates the channel number; i.e., R1027 refers to a Channel 1 resistor, and X7216 refers to a Channel 7 jumper, etc.
- Components in the Master section are preceded by the number “9” (X901, etc.).
- The circuit board contains holes where resistors are to be added.
- A single drop of solder can serve as a jumper between adjacent jumper pads.
- All Channel modifications in this section use Channel 1 as an example.

### Inserting A 15 dB Microphone Preamplifier Pad

Each channel's microphone preamplifier gain can be reduced by 15 dB. This may be desirable with extremely high-output microphones.

To pad the gain of the MIC position:

1. Remove surface mount resistor R1023.
2. Solder a 680  $\Omega$  resistor at jumper X112. For a greater gain reduction, use a resistor with a value greater than 680  $\Omega$ . Use a lesser value resistor for less reduction.

To pad the gain of the PHM (phantom) position:

1. Remove surface mount resistor R1026.
2. Solder a 1.5 k $\Omega$  resistor at jumper X110. This reduces gain by 8 dB. For a greater gain reduction, use a resistor with a value greater than 1.5 k $\Omega$ . Use a lesser value resistor for less reduction.

**NOTE:** To compensate for higher output condenser microphones, the factory-set gain in the PHM position is 13 dB lower than the gain in the MIC position.

## Line-Level Output to Mic-Level Output

Procedure:

1. Short jumper X901.
2. Remove resistors R900 and R909.

## Disable Master Level Control

The Master gain control can be disabled so it cannot be tampered with. The following table indicates the resistor value to be used for the desired gain.

Master Section Gain	Resistance
-6 dB	5.1 k $\Omega$
0	10 k $\Omega$
6 dB	20 k $\Omega$

Procedure:

Remove resistor R9230. Install new resistor at jumper X914.

## Change Limiter Threshold

All three threshold settings (+16, +8 and +4 dBm) can be changed. To shift the threshold down by 6 dB, resistor R will be 82 k $\Omega$ . To shift the limiter thresholds up by 6 dB, R will be 330 k $\Omega$ .

Procedure:

1. Remove resistors R9177 and R9180.
2. Install new resistor R at jumper X907.

## Local Aux Operation

With linked mixers, the Aux input from a modified mixer does not link.

Procedure:

Remove resistor R9024.

## Send/Return (Insert) to Direct Out

Changes a channel's ¼-inch insert jack to a Direct Out jack.

1. Remove jumpers at X101, X102, X105 and X106, and X808 if modifying channel 8.
2. Short resistors R1011 and R1020.

## Send/Return to Direct Out Post-Fader

A channel's Insert phone jack can be changed to Direct Out, post-fader.

1. Remove jumpers at X101, X102 and X105.
2. Short resistors at R1020.

## Remote Volume Control of Channels

The channel, aux, or master levels can be controlled remotely by a dc voltage via an external VCA (Voltage Controlled Amplifier). An example of an external VCA is the ST-VCA1 from Radio Design Labs (1-800-281-2683 or [www.rdl.net.com](http://www.rdl.net.com)).

Procedure:

For channel control:

1. Connect the tip of a ¼-in. connector to the line input of the VCA, and the sleeve to the ground of the VCA.
2. Connect the ring to the line output of the VCA.
3. Plug the ¼-in. connector to the Insert jack of the SCM800.
4. Set the channel level control should be set to 5.

For Aux In control:

1. Connect the external source to the VCA line input.
2. Connect the VCA line output to the tip and sleeve of the SCM800 Aux input.
3. Set the Aux control to 5.

For Master control:

1. Connect SCM800 Line output to the VCA line input.
2. Connect the VCA line output to the external device (amplifier, tape recorder, etc.).
3. Set Master control to 5.

## Specifications

Frequency Response

Voltage Gain

(typical, controls full clockwise)

Total Harmonic Distortion

<0.1% at +18 dBV output level, 50 Hz to 20 kHz (through 20 Hz-20 kHz filter); Input 1 and Master at 5, all other controls full counterclockwise)

Hum and Noise

<b>Equivalent Input Noise</b>	-125 dBV (150 Ω source; through 400 Hz-20 kHz filter)
<b>Equivalent Input Hum and Noise</b>	-123 dBV (150 Ω source; through 20 Hz-20 kHz filter)
<b>Output Hum and Noise</b>	through 20 Hz-20 kHz filter; channel controls full counterclockwise
<b>Master full counterclockwise</b>	-90 dBV
<b>Master full clockwise</b>	-62 dBV

Common Mode Rejection Ratio

>70 dB at 1 kHz

## Polarity

Mic/Line, Send inputs to all outputs are non-inverting; Aux input to all outputs is inverting

## Overload and Shorting Protection

Shorting outputs, even for prolonged periods, causes no damage. Microphone inputs are not damaged by signals up to 3 V; Lines and Monitor inputs by signals up to 20 V

## Equalization

<b>Low-frequency</b>	6 dB/octavecut, adjustable corner from 25 to 320 Hz
<b>High-Frequency</b>	±6dB/octaveat 5 kHz, ± dBat 10 kHz, shelvingat 5

## Limiter

<b>Type</b>	Peak
<b>Threshold</b>	Switchable: off, +4, +8, +16 ( dBm at output)
<b>Attack</b>	2 ms
<b>Recovery</b>	300 ms
<b>Indicator</b>	Lights red when limiting occurs

## Input LEDs

Light at 6 dBbelow clipping

## Phantom Power

46 V DC open-circuit through6.8 k  $\Omega$  series resistance per DIN 45 596

## Operating Voltage

<b>SCM800</b>	120 V AC rated nominal, 50/60 Hz, 200 mA
<b>SCM800E</b>	230 V AC rated nominal, 50/60 Hz, 100 mA

## Temperature Range

<b>Operating Temperature</b>	0° to 60° C (32° to140° F)
<b>Storage Temperature</b>	-30° to 70° C (-22° to158° F)

## Dimensions

44.5 mm H x 483 mm W 317 mm D (1¾ x 19 x 12½ in.)

## Net Weight

4.3 kg (9 lb ., 9 oz.)

## Inputs

Input	Impedance		Input Clipping Level
	Designed for use with	Actual (typical)	
<b>Mic</b>	19–600 $\Omega$	10 k $\Omega$	-12 dBV
<b>Line</b>	$\leq 2$ k $\Omega$	10 k $\Omega$	+22 dBV
<b>Aux</b>	$\leq 2$ k $\Omega$	10 k $\Omega$	+22 dBV
<b>Send/Return</b>	$\leq 2$ k $\Omega$	10 k $\Omega$	+18 dBV

## Outputs

Output	Impedance		Output Clipping Level
	Designed for use with	Actual (typical)	
<b>Line</b>	>600 $\Omega$	60 $\Omega$	-18 dBV
<b>Headphone</b>	8–200 $\Omega$ (60 $\Omega$ recommended)	300 $\Omega$	+12 dBV
<b>Direct Output</b>	>2 k $\Omega$	1 k $\Omega$	+18 dBV
<b>Send/Return</b>	>2 k $\Omega$	1 k $\Omega$	+18 dBV

## Replacement Parts

<b>Knob, Channel Gain and Phones (white)</b>	95A8238
<b>Knob, Master (blue)</b>	95B8752
<b>Line (Power) Cord (SCM800)</b>	95B8389
<b>230 VAC Power Line Cord</b>	95B8247
<b>Link Cable</b>	95B8889
<b>Three -Terminal Block Connector</b>	95B8580

## Service Statement

For additional service or parts information, please contact Shure's Service department at 1-800-516-2525. Outside the United States, please contact your authorized Shure Service Center.



---

# Certifications

SCM800: Listed by Underwriters Laboratories, Inc.; Certified by Canadian Standards Association; SCM800E: Conforms to European Union Directives; Certified to EN60065; Eligible to bear CE Marking; Conforms to European EMC Directive 2004/108/EC; Meets Harmonized Standards EN55103-1:1996 and EN55103-2:1996 for residential (E1) and light industrial (E2) environments.

This product meets the Essential Requirements of all relevant European directives and is eligible for CE marking.

The CE Declaration of Conformity can be obtained from: [www.shure.com/europe/compliance](http://www.shure.com/europe/compliance)

Authorized European representative:

Shure Europe GmbH

Headquarters Europe, Middle East & Africa

Department: EMEA Approval

Jakob-Dieffenbacher-Str. 12

75031 Eppingen, Germany

Phone: +49-7262-92 49 0

Fax: +49-7262-92 49 11 4

Email: [info@shure.de](mailto:info@shure.de)